

Open-File Report 96-229

Construction, Lithologic, and Water-Level Data for Wells Near the Dickson County Landfill, Dickson County, Tennessee, 1995

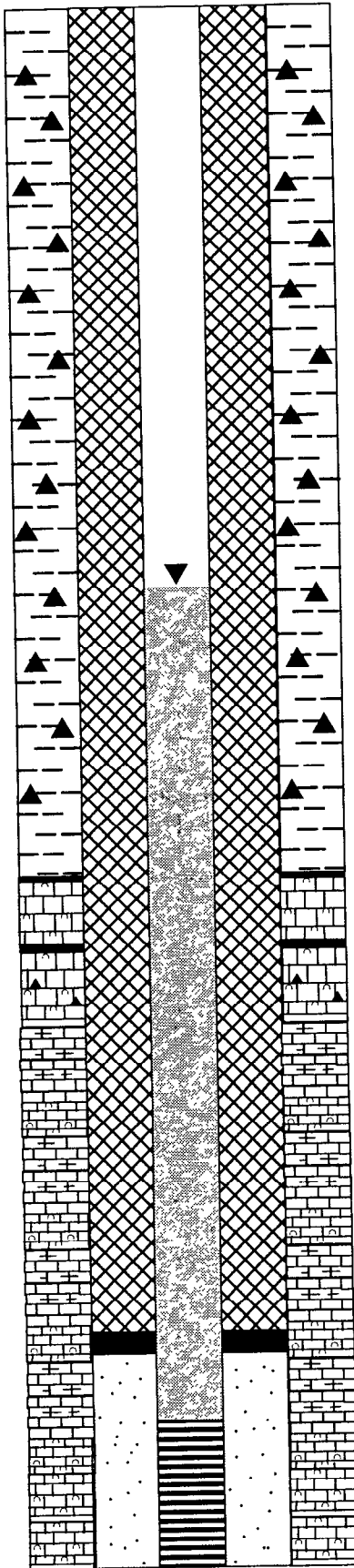

Prepared by the
U.S. GEOLOGICAL SURVEY

in cooperation with
DICKSON COUNTY SOLID WASTE MANAGEMENT,
DICKSON COUNTY, TENNESSEE

Cover illustration: Graphic by E.G. Baker.

Construction, Lithologic, and Water-Level Data for Wells Near the Dickson County Landfill, Dickson County, Tennessee, 1995

By DAVID E. LADD

U.S. GEOLOGICAL SURVEY

Open-File Report 96-229

**Prepared in cooperation with
DICKSON COUNTY SOLID WASTE MANAGEMENT,
DICKSON COUNTY, TENNESSEE**



Nashville, Tennessee

1996

**U.S. DEPARTMENT OF THE INTERIOR
BRUCE BABBITT, Secretary**

**U.S. GEOLOGICAL SURVEY
Gordon P. Eaton, Director**

Any use of trade, product, or firm name in this report is for identification purposes only and does not constitute endorsement by the U.S. Geological Survey.

For additional information write to:

**District Chief
U.S. Geological Survey
810 Broadway, Suite 500
Nashville, Tennessee 37203**

Copies of this report may be purchased from:

**U.S. Geological Survey
Earth Science Information Center
Open-File Reports Section
Box 25286, MS 517
Denver Federal Center
Denver, Colorado 80225**

CONTENTS

| | |
|---|---|
| Abstract | 1 |
| Introduction | 1 |
| Description of the study area | 1 |
| Well construction | 3 |
| Lithology | 5 |
| Water-level data | 5 |
| Summary..... | 5 |
| References cited..... | 5 |
| Appendix—Well-construction diagrams and lithology | 9 |

FIGURES

| | |
|--|---|
| 1-3. Maps showing: | |
| 1. Location of the study area..... | 2 |
| 2. Location of new monitoring wells installed at the Dickson County landfill, in Tennessee | 4 |
| 3. Location and water-level altitudes of measured wells, Dickson County, Tennessee, June 1 and 2, 1995 | 6 |

TABLES

| | |
|--|---|
| 1. Construction data for new monitoring wells installed near the Dickson County landfill, in Tennessee | 3 |
| 2. Water-level data for wells near the Dickson County landfill, in Tennessee, June 1 and 2, 1995 | 7 |

CONVERSION FACTORS, VERICAL DATUM, AND WELL-NUMBERING SYSTEM

| Multiply | By | To obtain |
|--|---------|-------------------------|
| inch (in.) | 25.4 | millimeter |
| foot (ft) | 0.3048 | meter |
| mile (mi) | 1.609 | kilometer |
| gallon (gal) | 3.785 | liter |
| gallon per minute (gal/min) | 0.06308 | liter per second |
| microsiemen per centimeter ($\mu\text{S}/\text{cm}$) | 1 | micromho per centimeter |

Temperature in degrees Fahrenheit ($^{\circ}\text{F}$) can be converted to degrees Celsius ($^{\circ}\text{C}$), and temperature in $^{\circ}\text{C}$ to $^{\circ}\text{F}$, as follows:

$$^{\circ}\text{F} = 1.8 ^{\circ}\text{C} + 32$$

$$^{\circ}\text{C} = 5/9(^{\circ}\text{F} - 32)$$

Sea Level: In this report “sea level” refers to the National Geodetic Vertical Datum of 1929 (NGVD of 1929)—a geodetic datum derived from a general adjustment of the first-order level nets of the United States and Canada, formerly called Sea Level Datum of 1929.

Site-numbering system: The U.S. Geological Survey assigned each site in this report a local Tennessee well number. The local well number is used as a concise label for a site. These numbers are used in addition to site and landfill numbers assigned by the author.

The local well number in Tennessee consists of three parts: (1) an abbreviation of the name of the county in which the well is located; (2) a letter designating the 7 1/2-minute topographic quadrangle on which the well is plotted; and (3) a number generally indicating the numerical order in which the well was inventoried. The symbol Di:F-89, for example, indicates that the well is located in Dickson County on the “F” quadrangle and is identified as well 89 in the numerical sequence. Quadrangles are lettered from left to right, beginning in the southwest corner of the county.

Construction, Lithologic, and Water-Level Data for Wells Near the Dickson County Landfill, Dickson County, Tennessee, 1995

By David E. Ladd

Abstract

Organic compounds were detected in water samples collected from Sullivan Spring during several sampling events in 1994. Prior to this, the spring was the drinking-water source for two families in the Dickson, Tennessee area. An investigation was conducted by the U.S. Geological Survey, in cooperation with Dickson County Solid Waste Management, to determine the local ground-water altitudes and to determine if Sullivan Spring is hydraulically downgradient from the Dickson County landfill. This report describes the data collected during the investigation. Five monitoring wells were installed near the northwestern corner of the landfill at points between the landfill and Sullivan Spring. Water-level measurements were made on June 1 and 2, 1995, at these wells and 13 other wells near the landfill to determine ground-water altitudes in the area. Water-level altitudes in the five new monitoring wells and three other landfill-monitoring wells were higher (750.04 to 800.17 feet) than the altitude of Sullivan Spring (approximately 725 feet). In general, wells in topographically high areas had higher water-level altitudes than Sullivan Spring and wells near streams in lowland areas.

INTRODUCTION

Organic compounds were detected in water samples collected from Sullivan Spring during several sampling events in 1994. Prior to this, the spring was the drinking-water source for two families in the Dickson, Tennessee area. In March, June, and September 1994, water samples were collected from two existing

landfill monitoring wells and Sullivan Spring, which is located approximately 0.3 mile northwest of the Dickson County landfill (fig. 1). Levels of trichloroethylene, cis-1,2-dichloroethylene, 1,2-dichloroethene, and cis-1,2-dichloroethene were detected in the samples obtained from Sullivan Spring. Water samples were then collected from Worley Furnace Branch upstream and downstream of the spring. These constituents were not detected upstream of Sullivan Spring (Griggs and Maloney, Inc., 1994).

An investigation was conducted by the U.S. Geological Survey (USGS), in cooperation with Dickson County Solid Waste Management, to determine local ground-water altitudes and to determine if Sullivan Spring is hydraulically downgradient from the Dickson County landfill. This investigation was part of an ongoing effort to better understand the hydrology and ground-water interaction at landfills along the Highland Rim physiographic region of Tennessee (Miller, 1974, p. 4-5). Five monitoring wells were installed near the previously unmonitored northwestern corner of the landfill between the landfill and the spring. Water levels were measured in the five new monitoring wells, three existing monitoring wells, and 10 local wells to determine the direction of ground-water flow in the area.

This report presents the data collected by the USGS during the course of the investigation. Well-construction diagrams and lithologic logs for the five new monitoring wells are included. Water-level altitudes and locations of all wells used in the study are reported.

DESCRIPTION OF THE STUDY AREA

The study area includes the Dickson County landfill and adjacent areas. The landfill lies approximately 1.5 miles southwest of the city of Dickson,

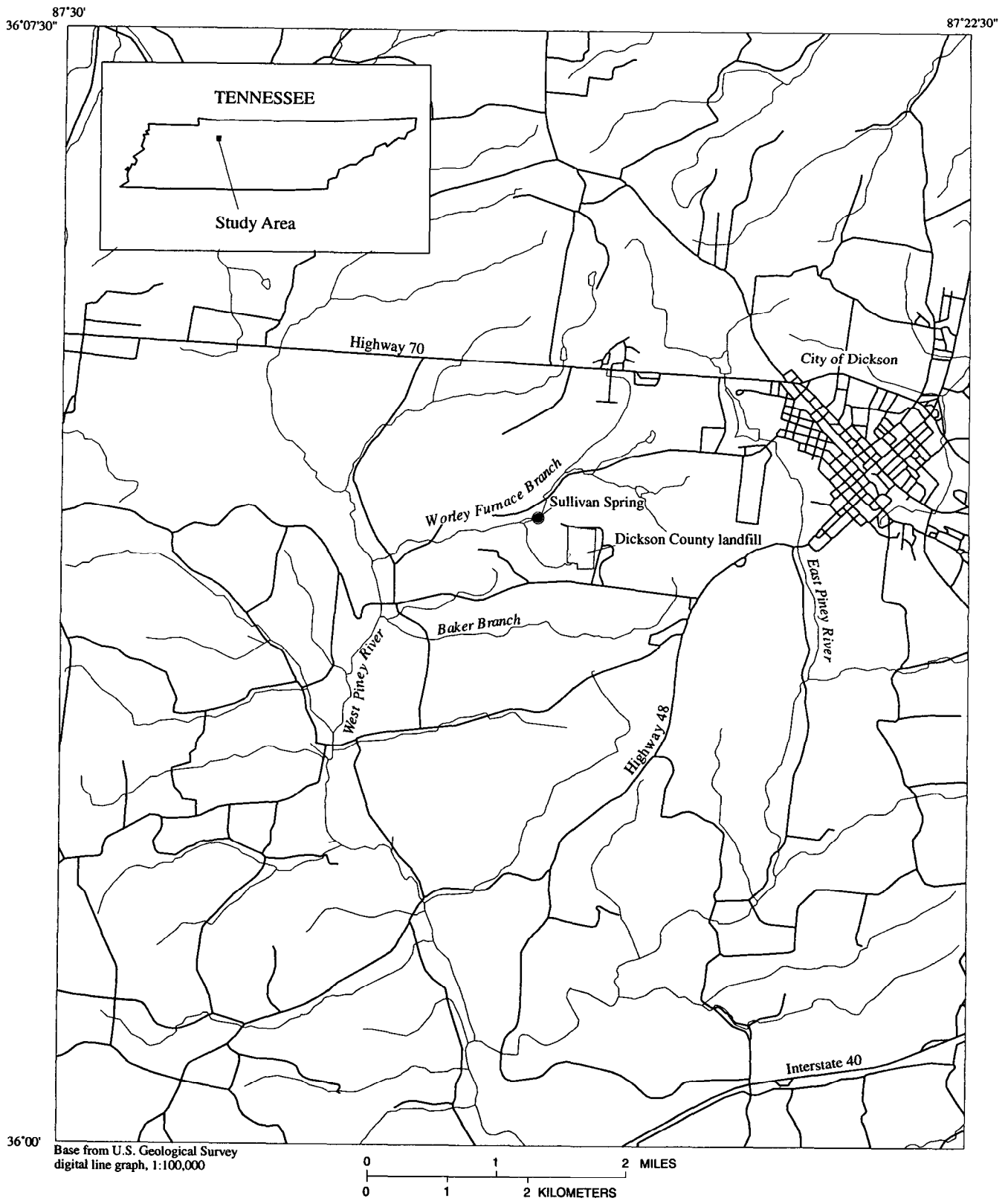

Figure 1. Location of the study area.

2 Construction, Lithologic, and Water-Level Data for Wells Near the Dickson County Landfill, Dickson County, Tennessee, 1995

Tennessee. The surface drainage in the area of the landfill is mostly northwest to Worley Furnace Branch, but some of the surface drainage is to the south to Baker Branch. Worley Furnace Branch and Baker Branch discharge to the West Piney River (fig. 1). Sullivan Spring, which feeds Worley Furnace Branch, lies approximately 0.3 mile northwest of the landfill. Parts of the landfill stand more than 120 feet higher than the spring and Worley Furnace Branch. The Dickson County landfill lies on the western Highland Rim physiographic region (Miller, 1974, p. 4-5). The geologic formations in the area of the landfill are Mississippian carbonates. They include, in descending order, the St. Louis Limestone, the Warsaw Limestone, and the Fort Payne Formation.

WELL CONSTRUCTION

Five monitoring wells were installed near the northwestern corner of the Dickson County landfill using standard air-rotary drilling technique (fig. 2). Wells 2 and 3 and wells 4 and 5 (fig. 2) form closely spaced well pairs containing a shallow and a deep well. The two shallow wells (2 and 4) were screened in the first water-yielding zone in regolith. In the three deep wells (1, 3, and 5), the regolith was cased off, and the wells were screened in a water-yielding zone in bedrock.

In each well, an 8.75-inch-diameter hole was drilled in regolith. In each deep well, the 8.75-inch-diameter hole was drilled about 5 feet into bedrock, and 6-inch-diameter steel casing was placed in the

hole. In each deep well, except MW6-R-01, the casing was sealed at the bottom by displacement with a cement/bentonite mixture to fill the entire annular space around the steel casing under ideal conditions. In MW6-R-01, the first well drilled during the study, only about 55 gallons of grout/bentonite mix was displaced into the annular space around the steel casing. Any unfilled annular space was filled with cuttings. After the cement/bentonite mixture was allowed to harden for at least 24 hours, a 6-inch-diameter hole was drilled through the mixture and into bedrock.

All of the new monitoring wells were installed with 2-inch-diameter polyvinylchloride (PVC) casing and a 0.010-inch slotted screen. In each well, except MW8-R-02, a sand pack was installed in the annular space around the screen from the bottom of the hole to at least 2 feet above the top of the screen. A bentonite seal at least 2 feet thick was placed above the sand pack. A cement/bentonite mixture was installed in the annular space around the 2-inch-diameter PVC casing from the top of the bentonite seal to land surface. Due to a large void encountered near the bottom of well MW8-R-02, a sand pack could not be placed around the screen. Instead, a PVC bushing was placed above the void, and the well was completed with a bentonite seal, a cement seal, and cement/bentonite grout. Well-construction information is included in table 1, and well-construction diagrams are included in the appendix.

Table 1. Construction data for new monitoring wells installed near the Dickson County landfill, in Tennessee

[Land-surface altitudes were determined by leveling to the top of well casings and subtracting height of above-ground casing intervals]

| Well number | | | Location | | | | | | Altitude of land surface, in feet above sea level | Depth of well, in feet below land surface | Screened interval, in feet | Date of construction |
|-------------|---------|-----------|----------|----|----|-----------|----|----|---|---|----------------------------|----------------------|
| Site | USGS | Landfill | Latitude | | | Longitude | | | | | | |
| 1 | Di:F-89 | MW6-R-01 | 36 | 04 | 08 | 87 | 25 | 50 | 843.28 | 183 | 163-183 | 4/25/95 |
| 2 | Di:F-90 | MW7-SH-02 | 36 | 04 | 11 | 87 | 25 | 49 | 830.19 | 103 | 93-103 | 4/27/95 |
| 3 | Di:F-91 | MW8-R-02 | 36 | 04 | 10 | 87 | 25 | 49 | 833.39 | 174 | 154-164 | 5/25/95 |
| 4 | Di:F-92 | MW9-SH-03 | 36 | 04 | 11 | 87 | 25 | 45 | 829.44 | 84 | 74-84 | 5/08/95 |
| 5 | Di:F-93 | MW10-R-03 | 36 | 04 | 10 | 87 | 25 | 43 | 844.81 | 162 | 142-162 | 5/30/95 |

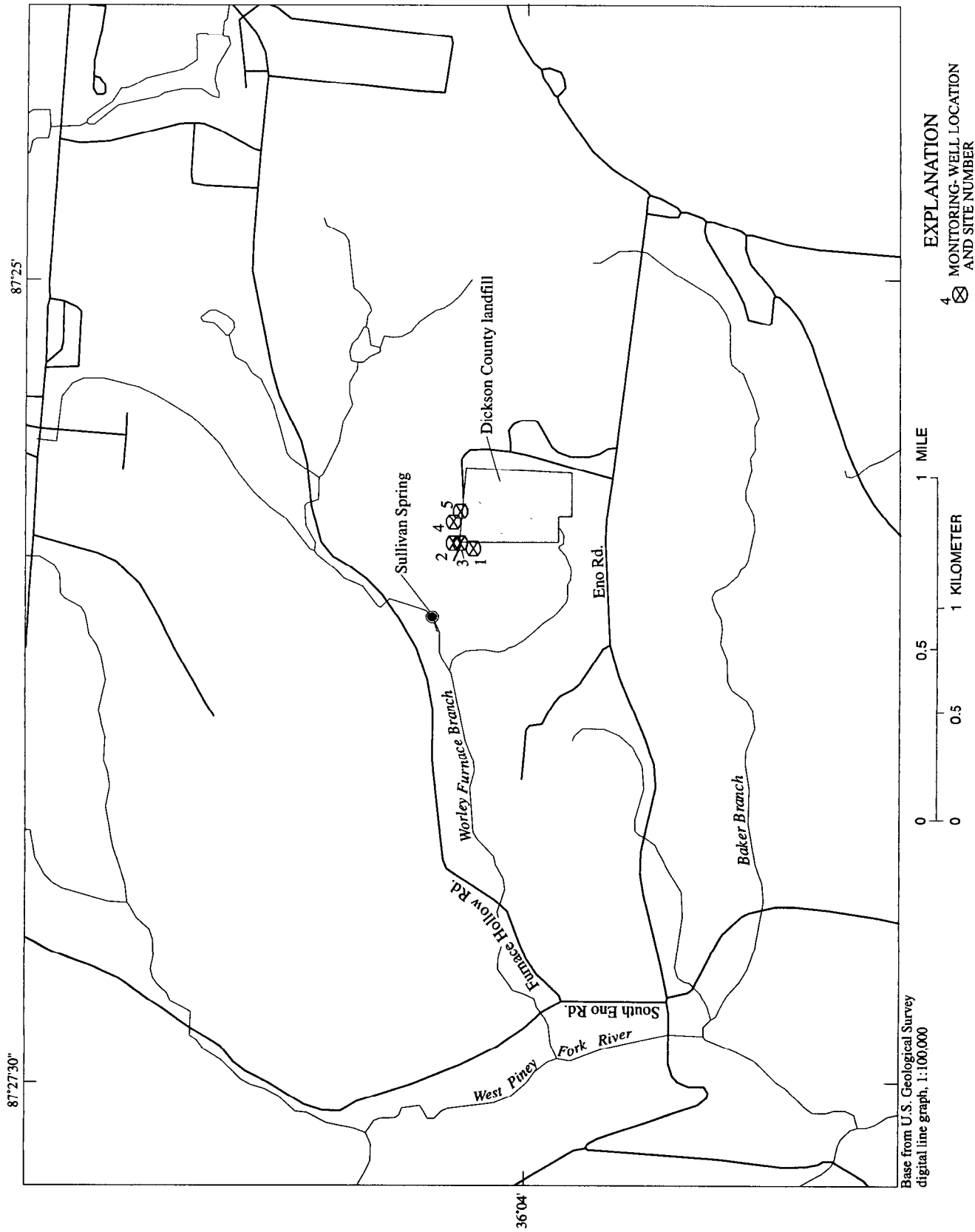

Figure 2. Location of new monitoring wells installed at the Dickson County landfill, in Tennessee.

LITHOLOGY

Geologic samples were collected at 5- to 10-foot intervals during well construction. A log was kept during drilling describing the lithology at each well. Lithologic logs of each well drilled are shown in the appendix.

Lithology encountered during drilling included clay, chert, and limestone. Regolith encountered was generally clay and chert gravel, with some limestone and chert boulders. Lithology encountered at top of bedrock generally was fine- to coarse-grained limestone, limestone and chert, or occasional silty limestone. Coarse- to very coarse-grained limestone was encountered near the bottom of each deep well.

WATER-LEVEL DATA

Water-level measurements were made on June 1 and 2, 1995, at 18 wells in the Dickson County landfill area (fig. 3). These wells include four local domestic wells, six wells owned by the city of Dickson, three existing landfill-monitoring wells, and the five new monitoring wells. Water-level altitudes were determined by using an electric tape to measure, to the nearest 0.01 foot, the distance from land surface to the top of the water column in each well, then subtracting this distance from the land-surface altitude of the well. Land-surface altitudes of landfill-monitoring wells were leveled to the nearest 0.01 foot. Land-surface altitudes for all other wells were determined from a 1:24,000-scale topographic map with a 20-foot contour interval. Well depths for the five new monitoring wells were obtained from construction logs. Well depths for other wells were determined by measuring to the nearest 0.5 foot unless otherwise noted in table 2.

The altitude of Sullivan Spring (approximately 725 feet), was lower and hydraulically downgradient from water-level altitudes in all of the monitoring wells at the landfill (ranging from 750.04 to 800.17 feet). In general, water-level altitudes in wells in the eastern part of the study area were higher than those in the western part of the study area (fig. 3 and table 2). Also, wells in topographically high areas had higher water-level altitudes than wells near major streams. Water-level altitudes ranged from 805.35 feet (well 12) to 689.10 feet (well 17). The water level in well 17, however, was a pumping level and did not represent a static water level. The next lowest water-

level altitude was 701.91 feet (well 18, the westernmost well measured during the study). Water-level altitudes for all wells measured during the study area are shown in figure 3.

SUMMARY

An investigation was conducted by the USGS, in cooperation with Dickson County Solid Waste Management, to determine the local ground-water altitudes and to determine if Sullivan Spring, approximately 0.3 mile northwest of the Dickson County landfill, Tennessee, is hydraulically downgradient from the landfill. As part of this investigation, five monitoring wells were installed near the northwestern corner of the landfill. Water-level measurements were made on June 1 and 2, 1995, from these wells and 13 other wells near the landfill.

Water-level altitudes in all of the monitoring wells at the landfill (ranging from 750.04 to 800.17 feet) were higher than and hydraulically upgradient from Sullivan Spring (approximately 725 feet). In general, water-level altitudes in wells in the eastern part of the study area were higher than those in the western part of the study area. Also, wells in topographically high areas had higher water-level altitudes than wells near major streams. Water-level altitudes ranged from 805.35 feet (well 12) to 689.10 feet (well 17). The water level in well 17, however, was a pumping level and did not represent a static water level. The next lowest water-level altitude was 701.91 feet (well 18, the westernmost well measured during the study).

REFERENCES CITED

- Bradley, M.W., 1984, Ground water in the Dickson area of the western Highland Rim of Tennessee: U.S. Geological Survey Water-Resources Investigations Report 82-4088, 42 p.
- Griggs and Maloney, Inc., 1994, Groundwater quality assessment plan, Dickson County landfill, Dickson County, Tennessee: File number 143-05.
- 1995, Groundwater assessment report, July 25-26, 1995, Dickson County landfill, Dickson County, Tennessee: File number 143-06.
- Miller, R.A., 1974, The geologic history of Tennessee: Tennessee Division of Geology Bulletin 74, 63 p.

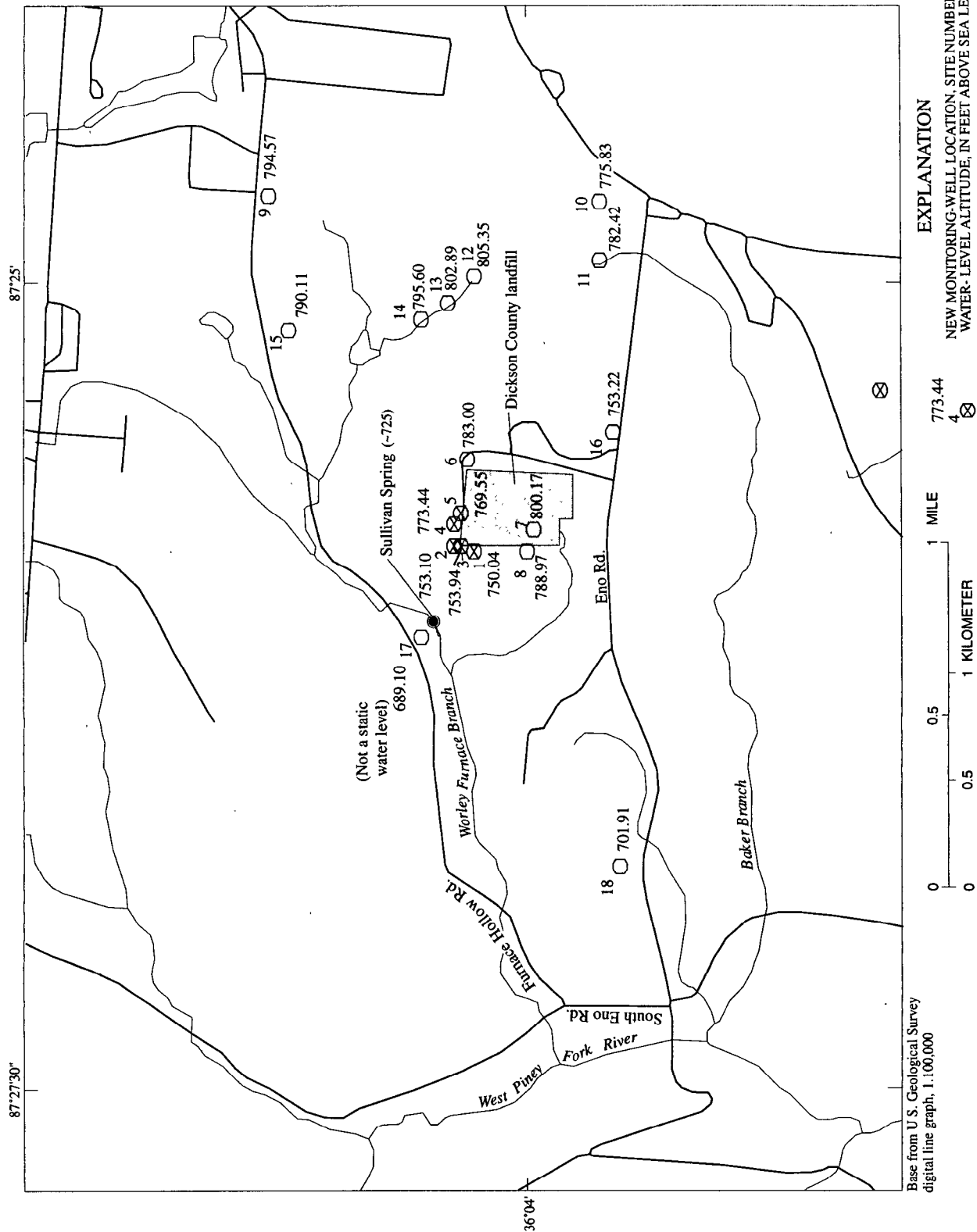

Figure 3. Location and water-level altitudes of measured wells, Dickson County, Tennessee, June 1 and 2, 1995.

Table 2. Water-level data for wells near the Dickson County landfill, in Tennessee, June 1 and 2, 1995

[Altitude of land surface for wells owned by the Dickson County landfill was determined by leveling to the top of casing and subtracting height of above-ground casing intervals. For all others, the altitude was estimated from a topographic map]

| Well number | | Location | | | Altitude of land surface, in feet above sea level | Depth of water level, in feet below land surface | Altitude of water level, in feet above sea level | Depth of well, in feet below land surface | Date of water-level measurement |
|-------------|---------|--|----------|-----------|---|--|--|---|---------------------------------|
| Site | USGS | Well owner | Latitude | Longitude | | | | | |
| 1 | Di:F-89 | Dickson County Solid Waste Management. | 36 04 08 | 87 25 50 | 843.28 | 93.24 | 750.04 | 183 | 6/02/95 |
| 2 | Di:F-90 | Dickson County Solid Waste Management. | 36 04 11 | 87 25 49 | 830.19 | 77.09 | 753.10 | 103 | 6/02/95 |
| 3 | Di:F-91 | Dickson County Solid Waste Management. | 36 04 10 | 87 25 49 | 833.39 | 79.45 | 753.94 | 174 | 6/02/95 |
| 4 | Di:F-92 | Dickson County Solid Waste Management. | 36 04 11 | 87 25 45 | 829.44 | 56.00 | 773.44 | 84 | 6/02/95 |
| 5 | Di:F-93 | Dickson County Solid Waste Management. | 36 04 10 | 87 25 43 | 844.81 | 76.16 | 769.55 | 162 | 6/02/95 |
| 6 | Di:F-86 | Dickson County Solid Waste Management. | 36 04 09 | 87 25 33 | 860.23 | 77.23 | 783.00 | ^a 85.75 | 6/01/95 |
| 7 | Di:F-87 | Dickson County Solid Waste Management. | 36 03 59 | 87 25 46 | 823.13 | 23.01 | 800.17 | 64.50 | 6/01/95 |
| 8 | Di:F-88 | Dickson County Solid Waste Management. | 36 04 00 | 87 25 50 | 823.73 | 34.76 | 788.97 | 84 | 6/01/95 |
| 9 | Di:F-94 | Street | 36 04 39 | 87 24 44 | 855 | 60.43 | 794.57 | ^b 340 | 6/02/95 |
| 10 | Di:F-76 | City of Dickson | 36 03 49 | 87 24 45 | 815 | 39.17 | 775.83 | ^c 300 | 6/01/95 |
| 11 | Di:F-73 | City of Dickson | 36 03 49 | 87 24 56 | 820 | 37.58 | 782.42 | ^c 350 | 6/01/95 |
| 12 | Di:F-70 | City of Dickson | 36 04 08 | 87 24 59 | 855 | 49.66 | 805.35 | ^c 320 | 6/01/95 |
| 13 | Di:F-78 | City of Dickson | 36 04 12 | 87 25 04 | 840 | 37.11 | 802.89 | ^c 160 | 6/01/95 |
| 14 | Di:F-84 | City of Dickson | 36 04 16 | 87 25 07 | 820 | 24.40 | 795.60 | ^c 250 | 6/01/95 |
| 15 | Di:F-95 | Hamrick | 36 04 36 | 87 25 09 | 840 | 49.89 | 790.11 | ^b 115 | 6/02/95 |
| 16 | Di:F-67 | City of Dickson | 36 03 47 | 87 25 28 | 815 | 61.78 | 753.22 | ^c 340 | 6/01/95 |
| 17 | Di:F-96 | Sullivan | 36 04 16 | 87 26 06 | 730 | ^d 40.90 | 689.10 | ^b 280 | 6/02/95 |
| 18 | Di:F-97 | Hamilton | 36 03 46 | 87 26 49 | 795 | 93.09 | 701.91 | -- | 6/01/95 |

^a Well depth from Griggs and Maloney, Inc., 1995.

^b Well depth from driller's report.

^c Well depth from Bradley, 1984.

^d Pump was running during measurement (static water level may be higher).

APPENDIX

Well-construction diagrams and lithology

EXPLANATION

WELL-CONSTRUCTION DIAGRAMS FOR WELLS COMPLETED IN ROCK

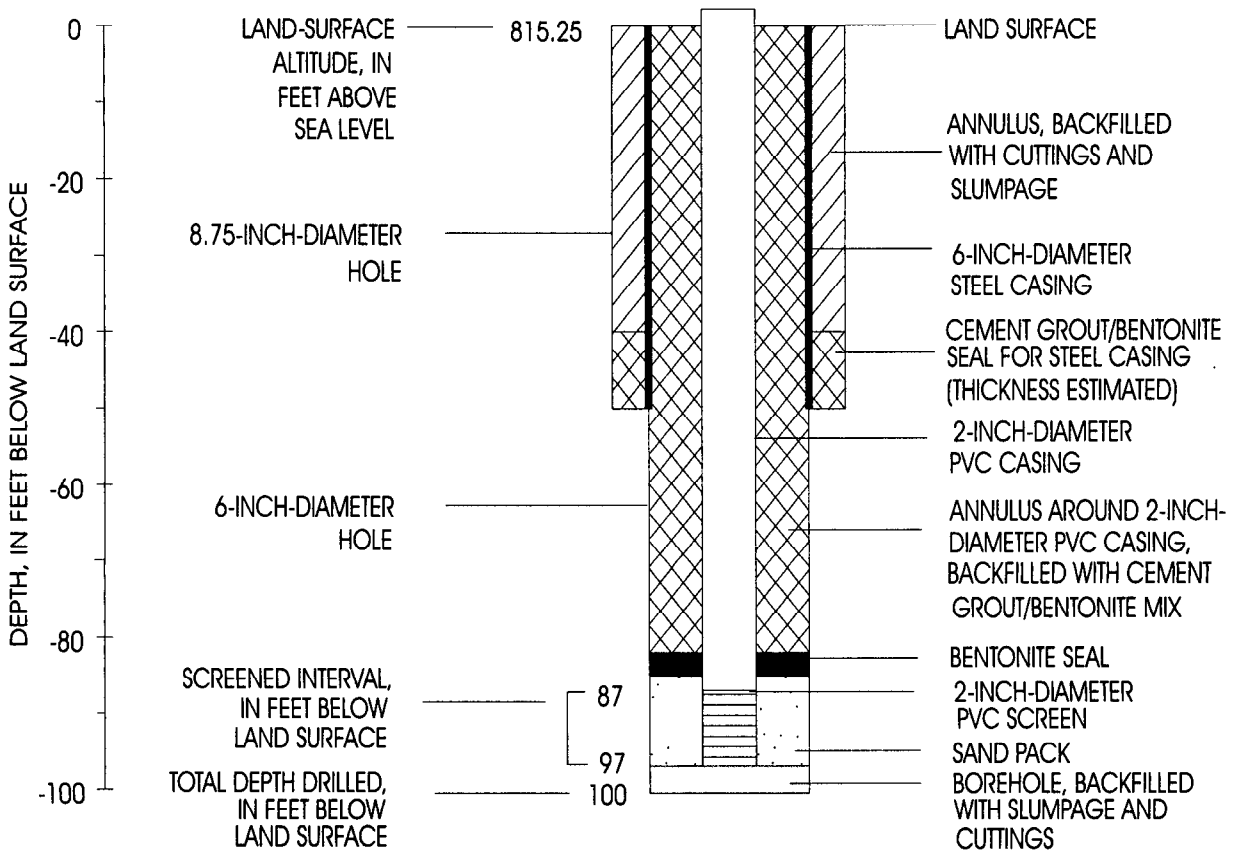

EXPLANATION

WELL-CONSTRUCTION DIAGRAMS FOR WELLS COMPLETED IN REGOLITH

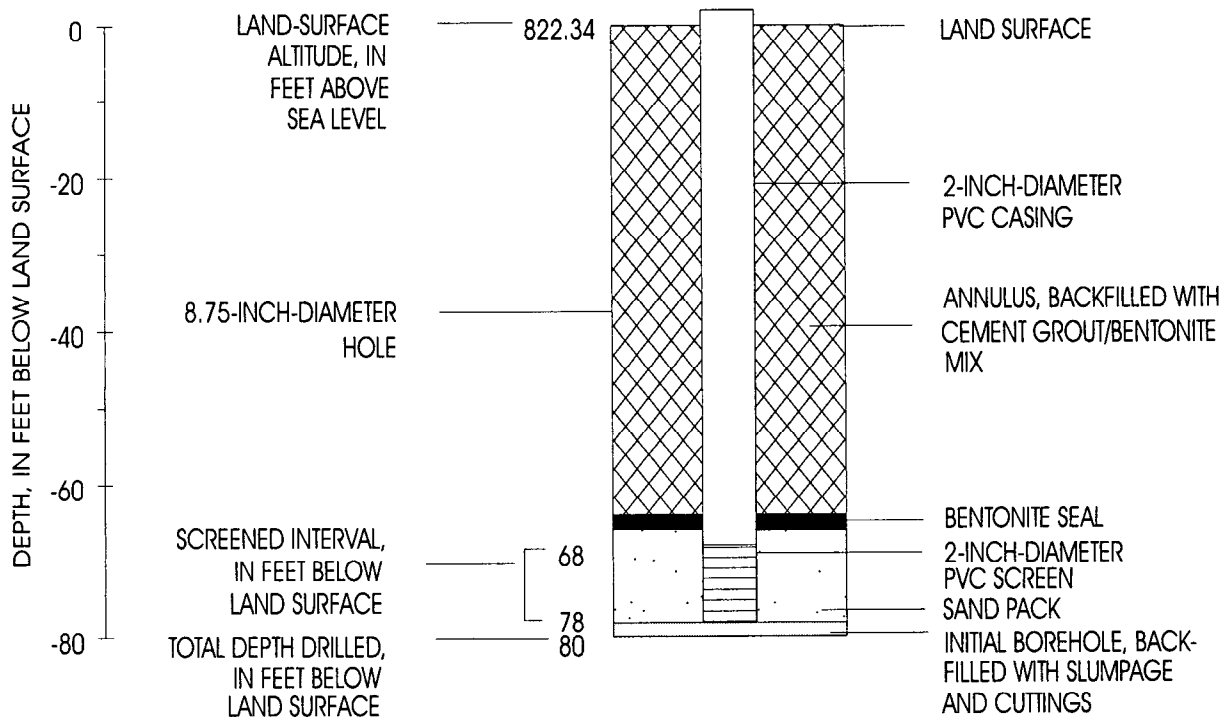

EXPLANATION

LITHOLOGY

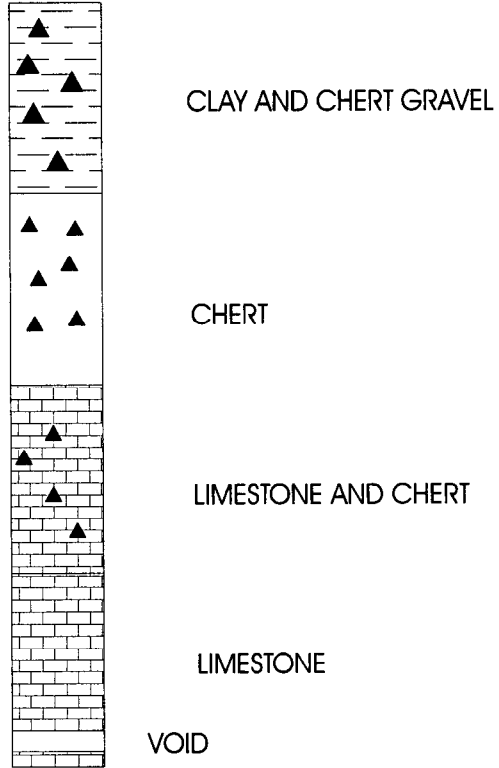

YIELD - ESTIMATED YIELD OF WATER-YIELDING ZONE IN GALLONS PER MINUTE (GAL/MIN)

S_{pC} - SPECIFIC CONDUCTANCE IN MICROSIEMENS PER CENTIMETER AT 25° CELSIUS OF WATER ENCOUNTERED DURING DRILLING

MW6-R-01

LITHOLOGY AND GEOLOGIST'S LOG

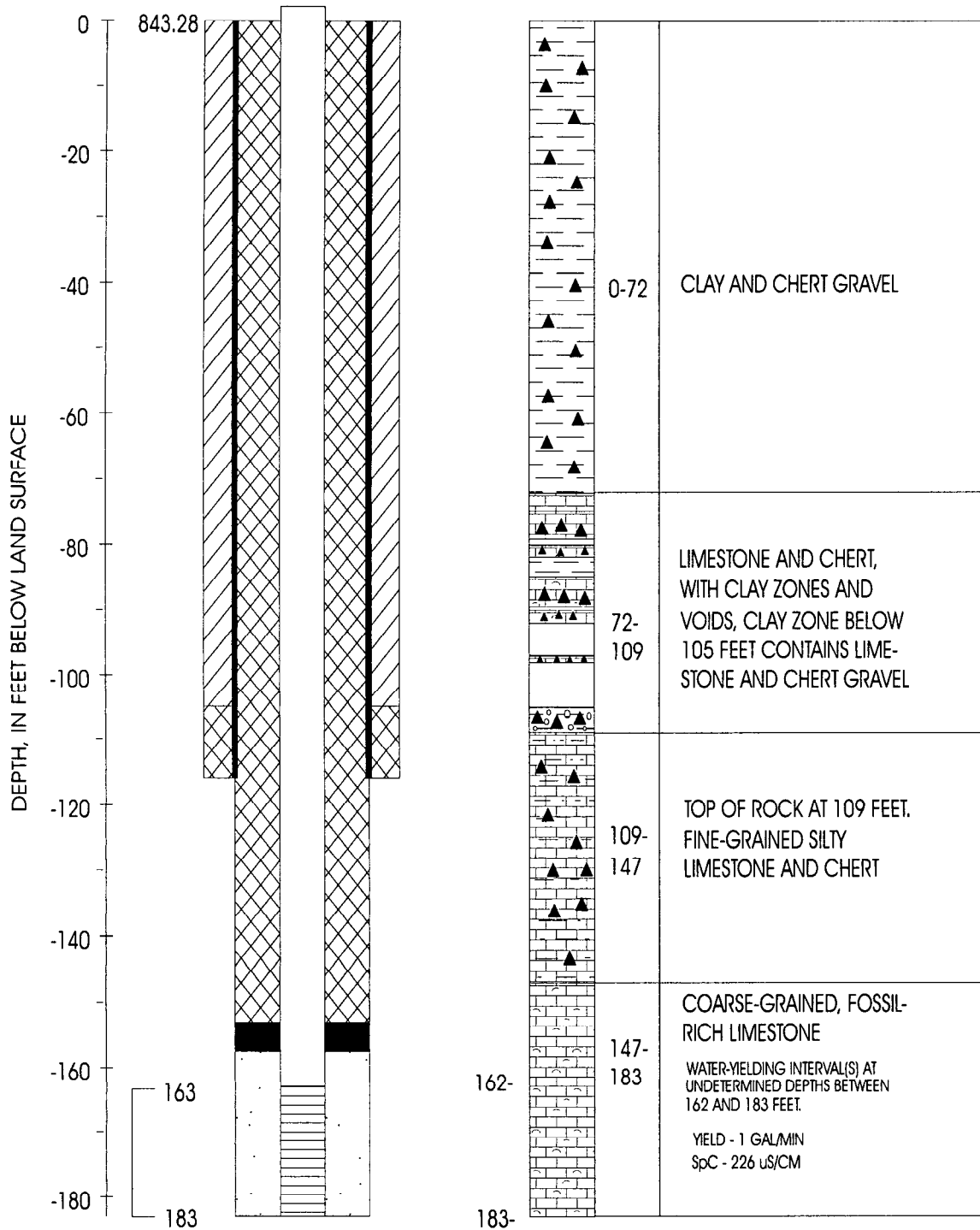

MW7-SH-02

LITHOLOGY AND GEOLOGIST'S LOG

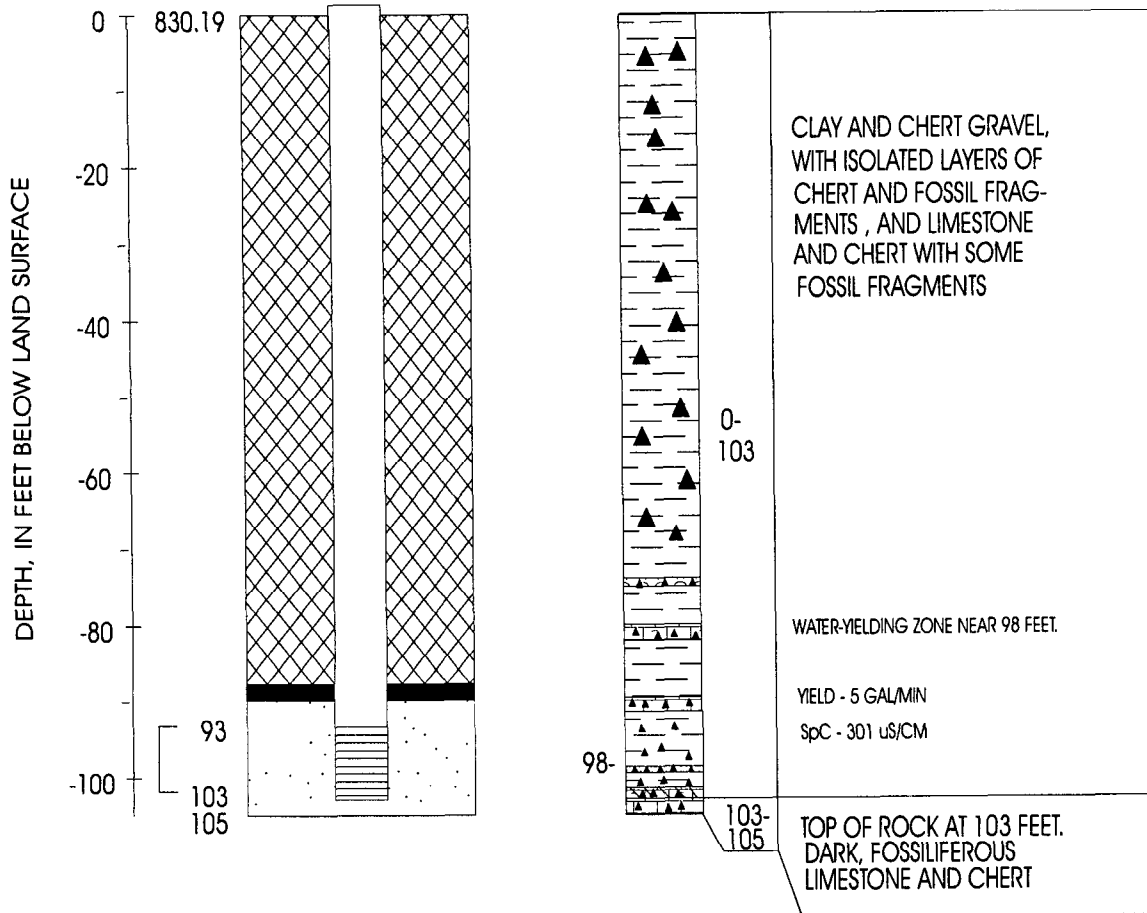

MW8-R-02

LITHOLOGY AND GEOLOGIST'S LOG

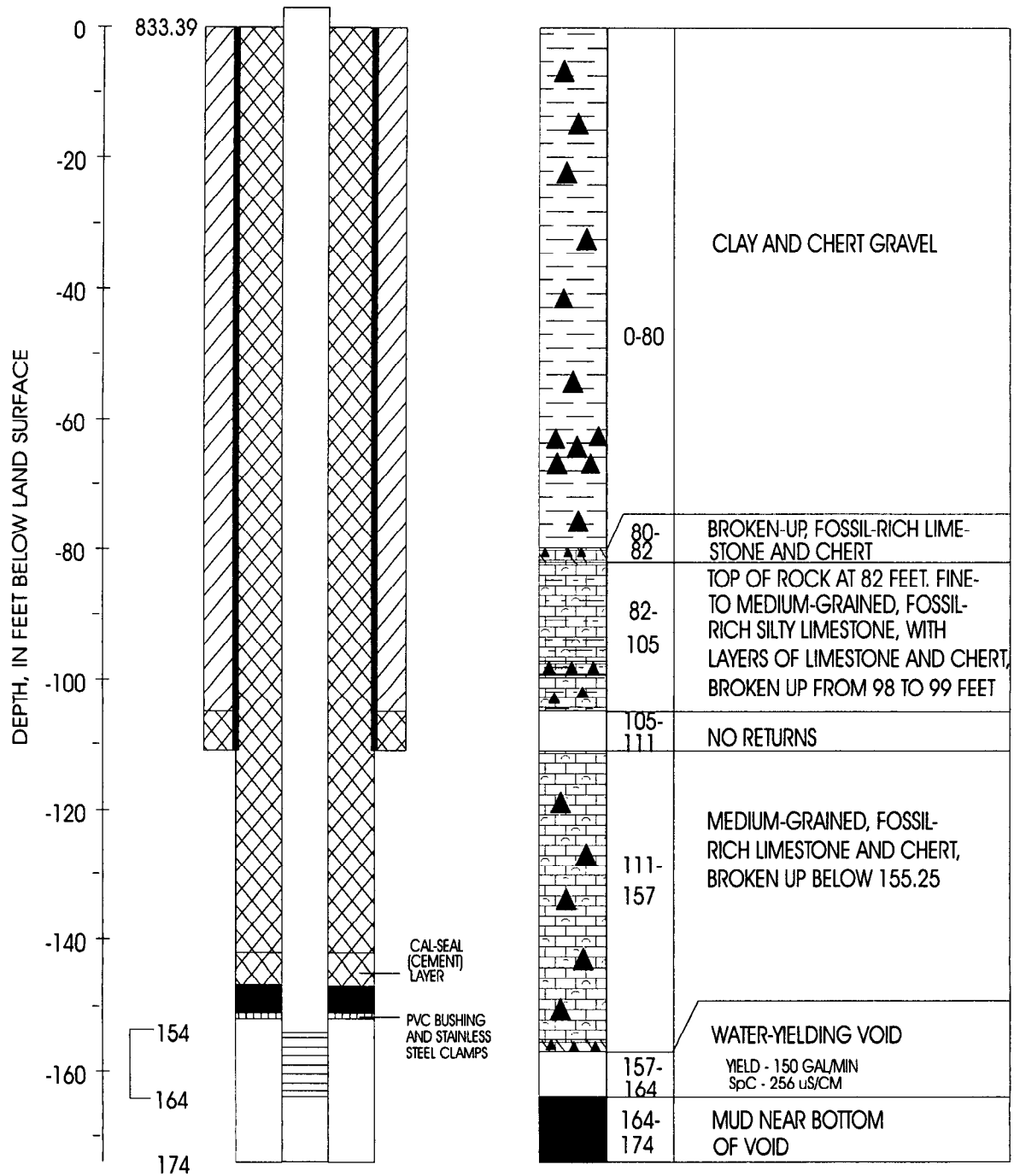

MW9-SH-03

LITHOLOGY AND GEOLOGIST'S LOG

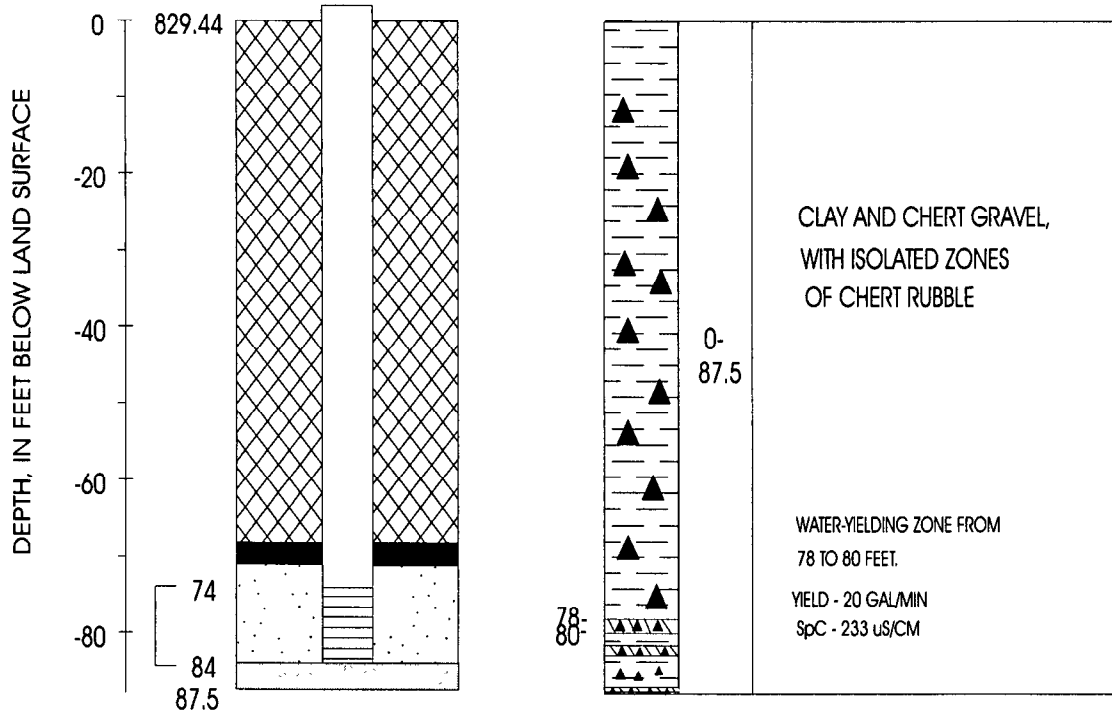

MW10-R-03

LITHOLOGY AND GEOLOGISTS LOG

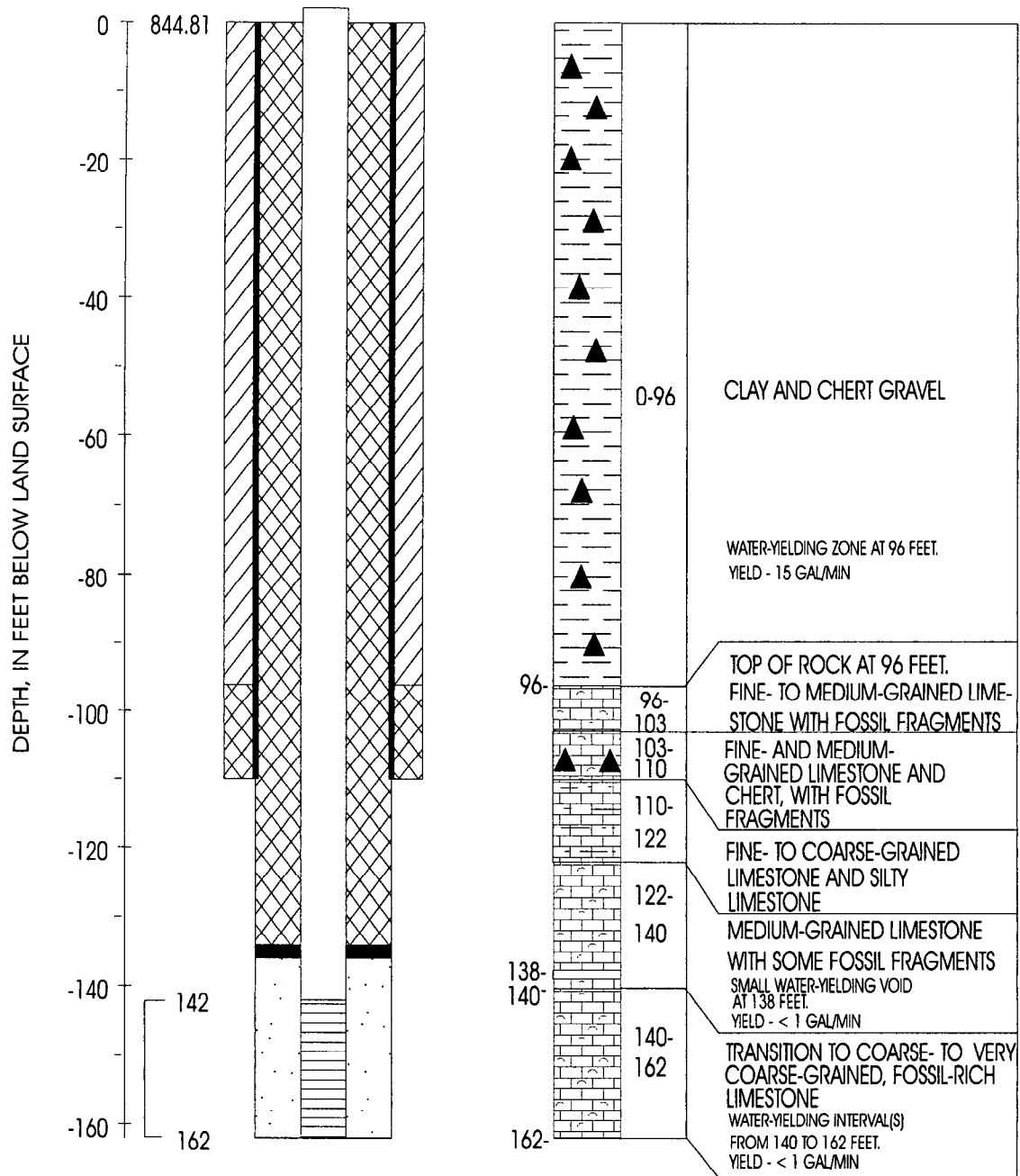

Ladd—CONSTRUCTION, LITHOLOGIC, AND WATER-LEVEL DATA FOR WELLS NEAR THE DICKSON—USGS/OFR 96-229
COUNTY LANDFILL, DICKSON COUNTY, TENNESSEE, 1995