

PV\_CTRL-1, Photovoltaic controller  
Morningstar SunSaver 10 amp

SOL-1, Solar panel, 60-80 watt  
Campbell Scientific, Model No. SP70-L

BATTERY-1, 12 VDC  
Optima, Model No. D34/78 or DM34, AGM Type, 75 AH

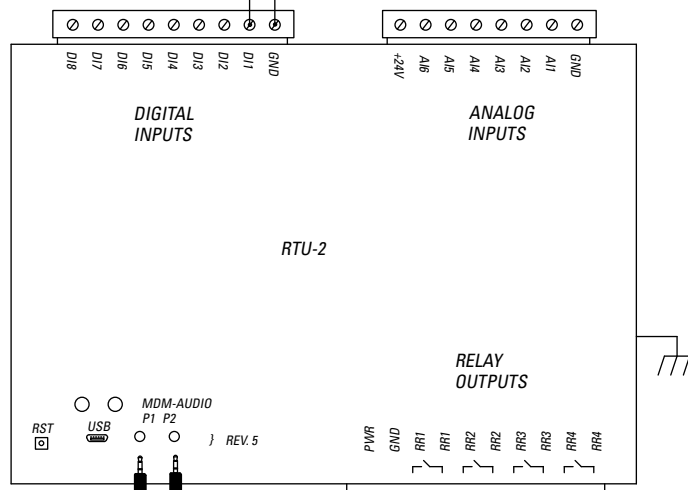

RTU-2, Remote terminal unit  
Rugid Computers, Model No. RUG3

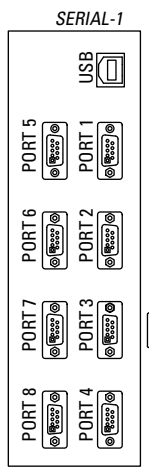

SERIAL-1, USB to 8-port serial adapter  
Qualtech, Model # ESU2-100

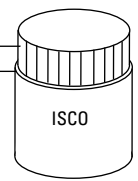

CABLE-1, Female DB9 To RJ45 4-wire  
Rugid Computers, Part # CBLR3PGM, 14 ft.

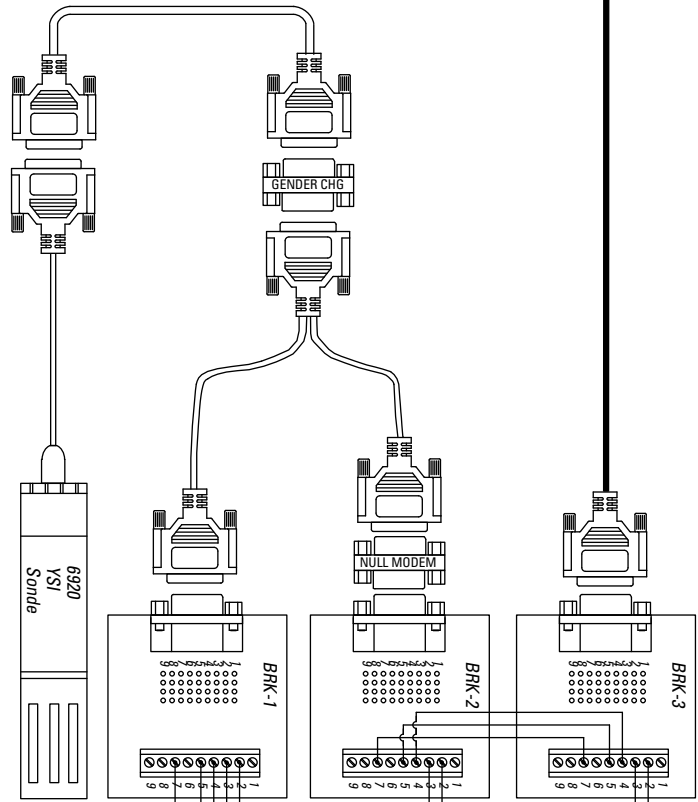

BRK-1; BRK-2; BRK-3, Breakout Boards  
DB9 Female to Screw terminal (QTY=2), DB9 Male to Screw terminal (QTY=1), DIN Rail Mount, Winford Engineering  
Part # BRK9F-S-DIN, and BRK9M-S-DIN

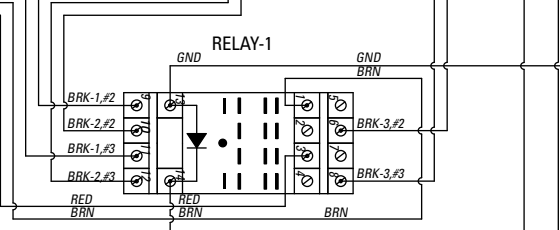

RELAY-1, Relay  
Magnecraft Model #782DX3M4L (12V, 3 AMP)  
RelaySocket-1, 11-Pin, Screw Terminal, 5/16 A, 300/600V  
Allied Electronics, Part# 70-465-1

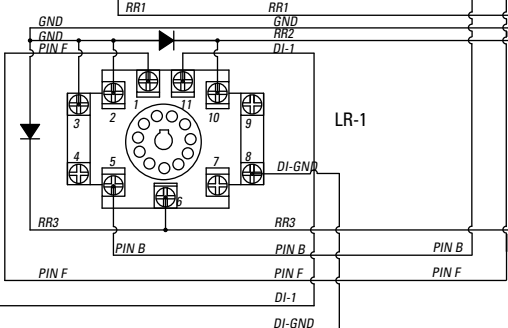
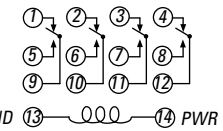

LR-1, Latching relay  
Magnecraft Model # W250ML2CPX-6 (12V, 16 AMP)  
RelaySocket-2, 4PDT, Screw Terminal, DIN/Panel Mount, IP20 Socket Allied Electronics, Part# 70-782D14-1

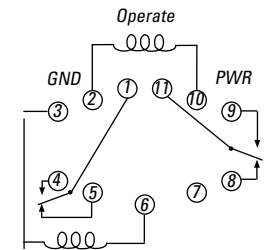

Diodes, 1-Amp Rectifier Diode, (QTY=3)  
RadioShack, Part # 1N4004